

**Cock straight, marking 6, drilling  
8,0 mm**

Order code: **6632.441340080**

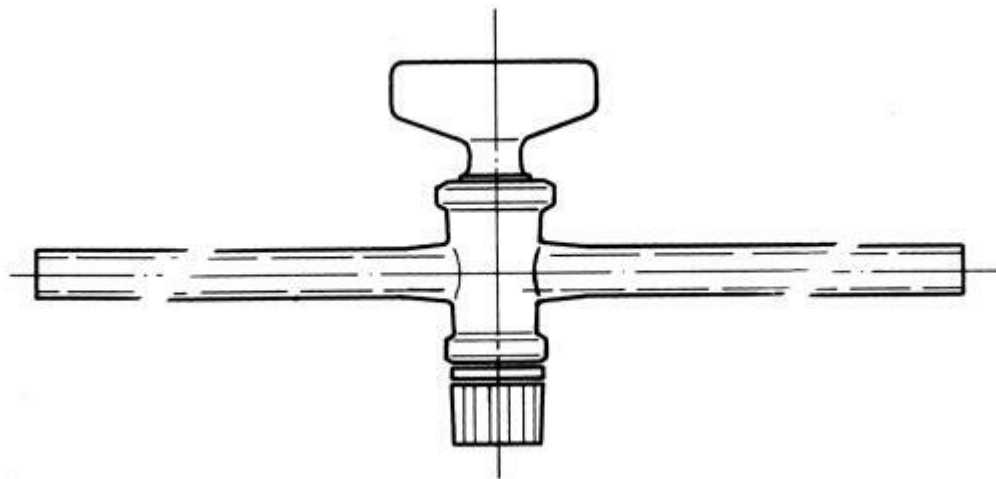

Cena bez DPH

59,30 Eur

Price with VAT

71,75 Eur

Parameters

d × l [mm]

15 x 120

Quantitative unit

ks