

**Cock straight, marking 4, drilling  
4,0 mm**

Order code: **6632.441340040**

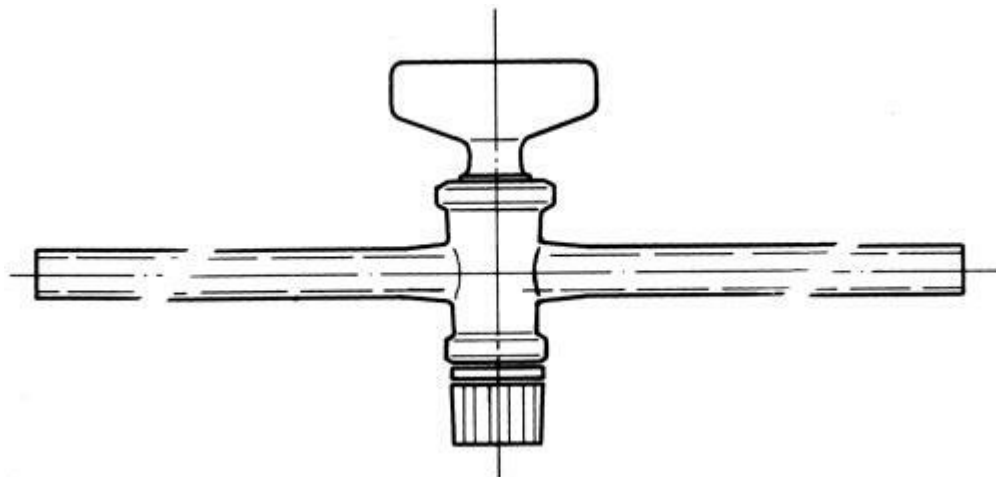

Cena bez DPH

34,40 Eur

Price with VAT

41,62 Eur

Parameters

d × l [mm]

10 x 110

Quantitative unit

ks